



Subject:

Performance data

Application: Refrigeration & AC

Refrigerant	R452A	Compressor refrigeration capacity	35.00 kW
Reference temperature	Dew point	Evaporator refrigeration capacity	35.00 kW
Power supply	50 Hz, 400 V	Power consumption	15.20 kW
Supply frequency	50 Hz	Current draw (400 V)	25.80 A
Evaporating temperature	-10.0 °C	Coefficient of performance (COP/EER)	2.29
<i>Evaporating pressure (abs.)</i>	<i>3.99 bar</i>	Condensing capacity	50.20 kW
Condensing temperature	45.0 °C	Mass flow	0.332 kg/s
<i>Condensing pressure (abs.)</i>	<i>19.83 bar</i>	Discharge end temperature	71.7 °C ¹⁾
Suction gas superheat	10 K		
Subcooling (outside cond.)	0 K		
Usable superheat	100%		



Preliminary capacity data.

-
- 1) The stated value of the discharge end temperature is a mere calculated value. Additional cooling and heat dissipation are not considered. Deviations (particularly in deep freezing applications) from the real measured discharge temperature during operation are possible.

Subject:

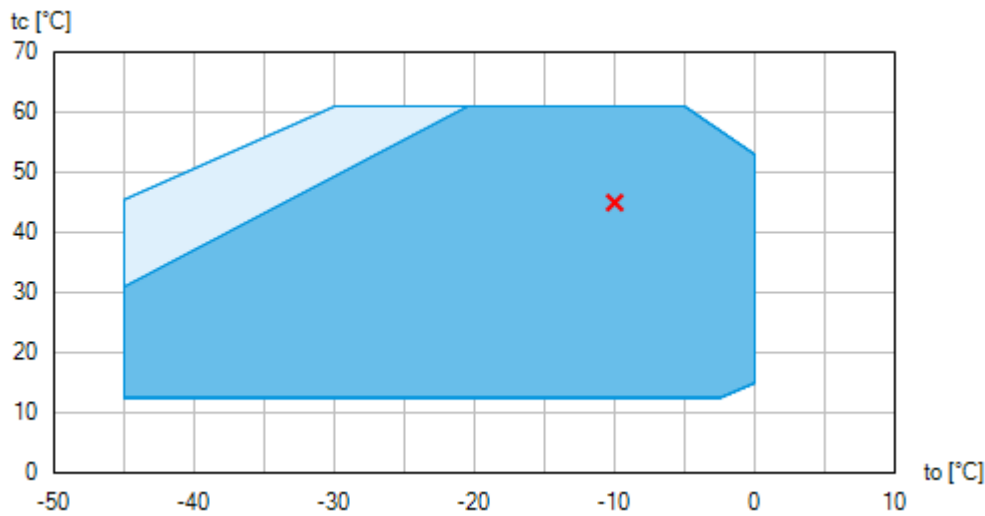
Operating limits



-  Unlimited application range
-  Supplementary cooling or reduced suction gas temperature ($\Delta t_{oh} < 20K$)

Compressor operation is possible within the limits shown on the diagrams of application. Please note the coloured areas. Compressor application limits should not be chosen for design purposes or continuous operation. Axis values refer to dew point (saturated vapour line).

Subject:

Technical data

Number of cylinders / Bore / Stroke	6 / 60 mm / 50 mm
Displacement 50/60 Hz (1450/1740 ¹ /min)	73,80 / 88,60 m ³ /h
Voltage ¹⁾	380-420V Y/YY -3- 50Hz PW
	440-480V Y/YY -3- 60Hz PW
Winding divided into	50% / 50%
Max. working current ²⁾	32.6 A
Max. power consumption ²⁾	19.7 kW
Starting current (rotor blocked) ²⁾	101.0 / 174.0 A
Motor protection	INT69 G
Protection terminal box	IP 66
Weight	194 kg
Frequency range ³⁾	25 - 70 Hz
Max. permissible overpressure (g) (LP/HP) ⁴⁾	19 / 28 bar
Connection suction line SV	54 mm - 2 1/8 "
Connection discharge line DV	35 mm - 1 3/8 "
Lubrication	Oil pump
Oil type R134a, R404A, R407A/C/F, R448A, R449A, R450A, R513A	BOCKlub E55
Oil type R22	BOCKlub A46
Oil charge	3,2 Ltr.
Oil sump heater	230 V - 1 - 50/60 Hz, 160 W
Dimensions Length / Width / Height	740 / 436 / 429 mm
Sound power level L _{WA} ⁵⁾	81 dB(A) @ -35 °C / +40 °C
	78 dB(A) @ -10 °C / +45 °C
Sound pressure level L _{pA} ⁵⁾	68 dB(A) @ -35 °C / +40 °C
	65 dB(A) @ -10 °C / +45 °C

1) Tolerance (± 10%) relates to the mean value of the voltage range. Other voltages and current types on request

All data are based on voltage rms values

PW = part winding, motors for part winding starting
 (no start unloaders required)
 Designs for Y/D on request

Subject to change without notice



Subject:

- 2) - The stated value for the max. power consumption is valid for the adjusted power supply.
 - Starting current (rotor blocked):
 - Part winding (PW) motors: Winding 1 / Winding 1+2
 - Delta/Star (Δ/Y) motors: Δ / Y
 - Take account of the max. operating current / max. power consumption for designing motor contractors, feed lines, fuses and motor protection switches. Motor contractors: Consumption category AC3.
- 3) The maximum permissible working current of the compressor (I_{max}) must not be exceeded. Take account of the guidelines for use of frequency inverter (see compressor assembly instruction or selection software).
- 4) LP = Low pressure
HP = High pressure
- 5) Declared dual-number noise emission values are in accordance with ISO 4871. The corresponding uncertainty to the sound power level is $K_{WA} = 2,5$ dB and to the sound pressure level is $K_{pA} = 2,5$ dB. The values are valid for 50 Hz with the refrigerant R404A at the standard rating points according to EN 12900.
 - A-weighted sound power level L_{WA} (re 1 pW), in decibel. To determine the values, measurement methods of the ISO 3740 standard with accuracy class 2 or higher were used .
 - A-weighted sound pressure level L_{pA} (re 20 μ Pa), in decibel. The values are calculated from the sound power level in accordance with ISO 11203: $L_{pA} = L_{WA} - Q_2$ at a distance of $d = 1$ m to the reference box.

Subject to change without notice

To:

From:

13.03.2026
Page 4 of 12



Subject:

Performance data table

Application: Refrigeration & AC
 Reference temperature: Dew point
 Supply frequency: 50 Hz
 Voltage: 400 V
 Suction gas superheat: 10 K
 Subcooling (outside cond.): 0 K

tc [°C]		to [°C]										
		0.0	-5.0	-10.0	-15.0	-20.0	-25.0	-30.0	-35.0	-40.0	-45.0	
10.0	Q [W] P [kW] I [A]											
15.0	Q [W] P [kW] I [A]	83600 7.91 16.40	69300 8.64 17.20	56800 8.99 17.60	46100 9.00 17.60	36900 8.73 17.30	29200 8.22 16.80	22800 7.52 16.00	17400 6.68 15.20	13000 5.76 14.30	9400 4.79 13.40	
20.0	Q [W] P [kW] I [A]	78800 9.95 18.70	65100 10.30 19.20	53200 10.30 19.20	43100 10.00 18.90	34400 9.56 18.30	27100 8.83 17.40	21000 7.94 16.50	15900 6.95 15.40	11700 5.90 14.40	8210 4.84 13.40	
25.0	Q [W] P [kW] I [A]	73900 11.80 21.10	60900 11.80 21.10	49700 11.50 20.80	40000 11.00 20.10	31900 10.20 19.10	25000 9.34 18.00	19200 8.28 16.80	14500 7.15 15.60	10500 6.00 14.50	7060 4.86 13.50	
30.0	Q [W] P [kW] I [A]	69000 13.50 23.30	56600 13.20 23.00	46000 12.60 22.20	37000 11.80 21.10	29300 10.80 19.90	22900 9.77 18.50	17500 8.56 17.10	13000 7.30 15.80	9160 6.06 14.50	5950 4.87 13.50	
35.0	Q [W] P [kW] I [A]	63900 15.00 25.50	52300 14.40 24.70	42400 13.60 23.50	33900 12.60 22.10	26800 11.40 20.60	20800 10.10 19.00	15700 8.78 17.40	11500 7.42 15.90	7930 6.10 14.60	4870 4.88 13.50	
40.0	Q [W] P [kW] I [A]	58900 16.40 27.60	48000 15.50 26.30	38700 14.50 24.70	30800 13.20 23.00	24200 11.80 21.10	18600 10.40 19.30	14000 8.95 17.60	10100 7.51 16.00	6730 6.14 14.60	3840 4.89 13.50	
45.0	Q [W] P [kW] I [A]	53800 17.70 29.50	43600 16.60 27.80	35000 15.20 25.80	27700 13.80 23.80	21600 12.20 21.70	16500 10.60 19.60	12300 9.11 17.80	8630 7.59 16.10	5560 6.18 14.70	2860 4.92 13.50	
50.0	Q [W] P [kW] I [A]	48600 18.90 31.30	39100 17.50 29.20	31200 15.90 26.80	24500 14.30 24.50	19000 12.60 22.10	14400 10.90 19.90	10500 9.25 17.90	7220 7.67 16.20	4420 6.24 14.70		
55.0	Q [W] P [kW] I [A]		34600 18.30 30.40	27400 16.50 27.80	21300 14.70 25.10	16400 12.90 22.50	12200 11.10 20.20	8750 9.38 18.10	5840 7.77 16.30			
60.0	Q [W] P [kW] I [A]		30000 19.00 31.60	23500 17.10 28.60	18100 15.10 25.70	13700 13.20 22.90	10100 11.30 20.40	7030 9.54 18.30				

Preliminary capacity data.

Supplementary cooling or reduced suction gas temperature ($\Delta t_{oh} < 20K$)

Subject to change without notice

To:

From:

13.03.2026
Page 5 of 12

BOCK® HGX56e/850-4
Engine: 380-420V Y/YY -3- 50Hz PW
Refrigerant: R452A



Subject:

t_o Evaporating temperature
t_c Condensing temperature
Q Compressor refrigeration capacity
P Power consumption
I Current draw

Subject to change without notice

To:

From:

13.03.2026
Page 6 of 12

VAP 11.15.3 – vap.danfoss.com

Subject:

Scope of supply

Semi-hermetic six-cylinder reciprocating compressor with drive motor
Single-section compressor housing with hermetically integrated electric motor

Rear bearing flange prepared for oil differential pressure sensor DELTA-P II

Winding protection with PTC resistor sensors and electronic trigger unit INT69 G
115-230 V AC, 50/60 Hz, IP00

Oil pump

Possibility of connection of oil level controllers ESK, AC+R or CARLY

Possibility of connection of oil level controllers Traxoil ¹⁾

Possibility for connection of oil pressure safety switch MP54

Oil charge:
HG: **BOCK**lub A46
HGX: **BOCK**lub E55

Sight glass

Pressure relief valve

Suction and discharge line valve

Inert gas charge

Accessories

(Digital) capacity regulator DCR14 230 V - 1 - 50/60 Hz, IP65
possible equipment see Capacity regulator 09900-DGbF

Cylinder cover prepared for digital capacity regulator

Oil sump heater 230 V - 1 - 50/60 Hz, 160 W

USB converter for INT69 G Diagnose ²⁾

Oil pressure safety switch MP54 230 V - 1 - 50/60 Hz, IP20 ²⁾

INT69 G Diagnose 115-230 V AC, 50/60 Hz, IP00 (INT69 G not applicable)

INT69 GTML Diagnose 115-230 V AC, 50/60 Hz, IP00, including oil differential pressure sensor INT250G,
thermal protection thermostat per cylinder covers, (INT69 G not applicable) ²⁾

Oil differential pressure sensor DELTA-P II 220-240 V - 1 - 50/60 Hz ²⁾

Connection piece suction and discharge valve in welding design

Thermal protection thermostat per cylinder cover

Oil temperature sensor (Pt1000, for external evaluation)

Subject to change without notice

BOCK® HGX56e/850-4
Engine: 380-420V Y/YY -3- 50Hz PW
Refrigerant: R452A



Subject:

Hot gas temperature sensor (Pt1000, for external evaluation) ³⁾

Thermal protection thermostat per cylinder cover

Additional fan
230 V AC - 1 - 50 Hz, 97 W, IP44
230 V AC - 1 - 60 Hz, 128 W ²⁾

Injection nozzle for liquid injection ²⁾

4 anti-vibration pads enclosed

Special voltage and/or frequency (on request)

-
- 1) Only with additional adapter possible
 - 2) Enclosure
 - 3) Mounted

Subject to change without notice

To:

From:

13.03.2026
Page 8 of 12

VAP 11.15.3 – vap.danfoss.com

BOCK® HGX56e/850-4
Engine: 380-420V Y/YY -3- 50Hz PW
Refrigerant: R452A



Subject:

Dimensions and connections

Subject to change without notice

To:

From:

13.03.2026
Page 9 of 12

VAP 11.15.3 – vap.danfoss.com

Subject:

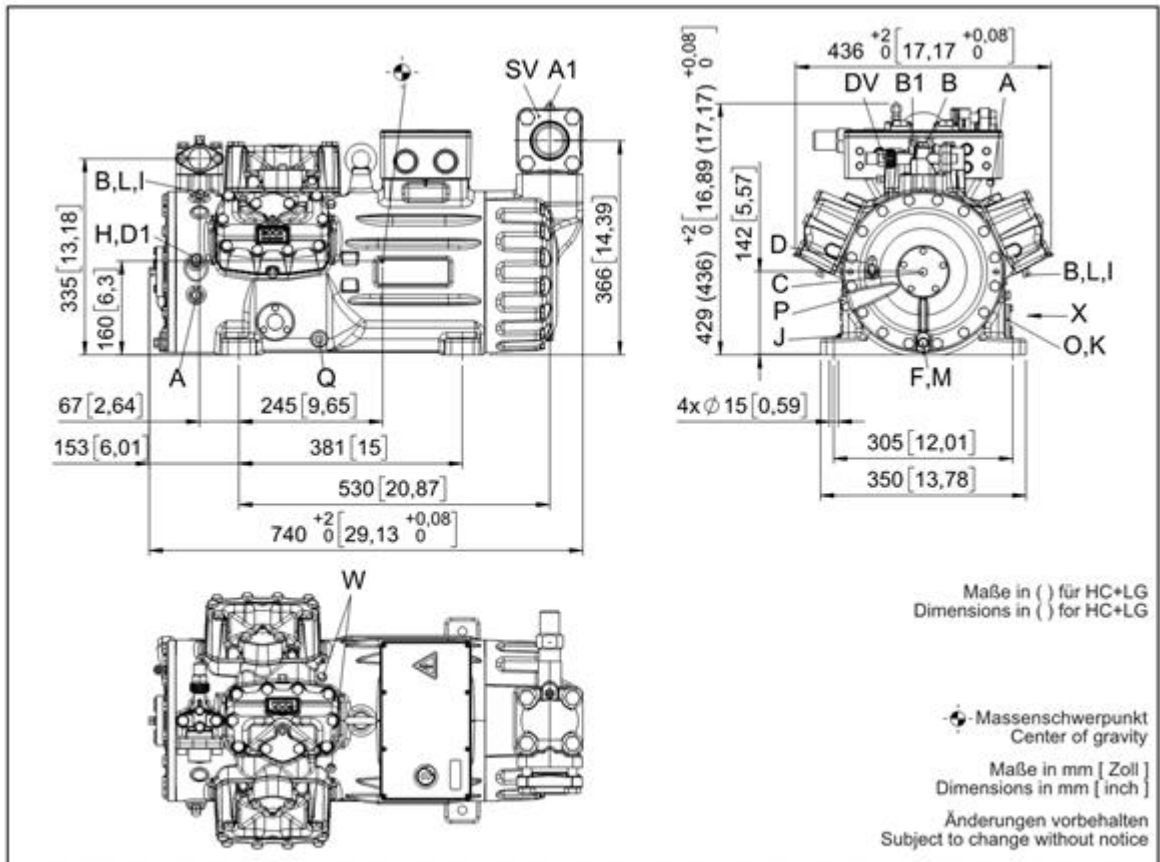

Maße Zubehör / Dimensions Accessories

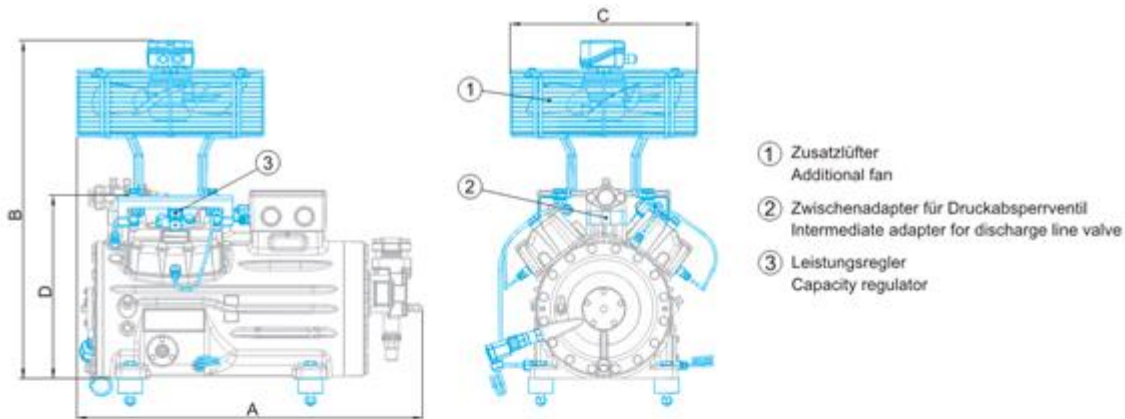

Typ / Type	A mm / inch	B mm / inch	C mm / inch	D mm / inch
HG12P	ca. 460 / 18	ca. 500 / 20	ca. 315 / 12	-
HG22e	ca. 525 / 21	ca. 610 / 24	ca. 380 / 15	-
HG34e	ca. 580 / 23	ca. 640 / 25	ca. 380 / 15	-
HG44e	ca. 710 / 28	ca. 685 / 27	ca. 380 / 15	368 / 14
HG56e	-	ca. 710 / 28	ca. 380 / 15	-
HG66e	ca. 820 / 32	ca. 800 / 31	ca. 380 / 15	-

Ansicht X: Anschlussmöglichkeit für Ölspiegelregulator
 View X: Possibility of connection of oil level regulator



- Dreilochanschluss für TRAXOIL (3xM6x10)
 Three-hole connection for TRAXOIL (3xM6x10)
- Dreilochanschluss für ESK, AC+R, CARLY (3xM6x10)
 Three-hole connection for ESK, AC+R, CARLY (3xM6x10)

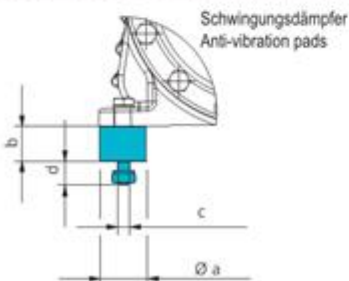

Typ / Type	Øa mm / inch	b mm / inch	c mm / inch	d mm / inch
HG12P	30 / 1.2	30 / 1.2	M8	20 / 0.8
HG22e	40 / 1.6	30 / 1.2	M10	20 / 0.8
HG34e	40 / 1.6	30 / 1.2	M10	20 / 0.8
HG44e	50 / 2.0	30 / 1.2	M12	25 / 1.0
HG56e	50 / 2.0	30 / 1.2	M12	25 / 1.0
HG66e	50 / 2.0	30 / 1.2	M12	25 / 1.0
HG88e	70 / 2.8	45 / 1.8	M12	37 / 1.5

ange without notice



Subject:

SV	Suction line valve, tube \varnothing ¹⁾	54 mm - 2 1/8 "
DV	Discharge line valve, tube \varnothing ¹⁾	35 mm - 1 3/8 "
A	Connection suction side, not lockable	1/8 " NPTF
A1	Connection suction side, lockable	7/16 " UNF
B	Connection discharge side, not lockable	1/8 " NPTF
B1	Connection discharge side, lockable	7/16 " UNF
C	Connection oil pressure safety switch OIL	1/8 " NPTF
D	Connection oil pressure safety switch LP	7/16 " UNF
D1	Connection oil return from oil separator	1/4 " NPTF
F	Oil drain	M 12 x 1.5
H	Oil charge plug	1/4 " NPTF
I	Connection hot gas temperature sensor	1/8 " NPTF
J	Connection oil sump heater	3/8 " NPTF
K	Sight glass	3 x M 6
L	Connection thermal protection thermostat	1/8 " NPTF
M	Oil strainer	M 12 x 1.5
O	Connection oil level regulator	3 x M 6
P	Connection oil differential pressure sensor	M 20 x 1.5
Q	Connection oil temperature sensor	1/8" NPTF
W	Connection for refrigerant injection	2 x 1/8 " NPTF

1) Brazing connection

BOCK® HGX56e/850-4
Engine: 380-420V Y/YY -3- 50Hz PW
Refrigerant: R452A



Subject:

Product photo



Subject to change without notice

To:

From:

13.03.2026
Page 12 of 12

VAP 11.15.3 – vap.danfoss.com