



**Subject:**

---

**Performance data**

**Application: Refrigeration & AC**

Refrigerant	R449A	Compressor refrigeration capacity	72.30 kW
Reference temperature	Dew point	Evaporator refrigeration capacity	72.30 kW
Power supply	50 Hz, 400 V	Power consumption	30.10 kW
Supply frequency	50 Hz	Current draw (400 V)	54.00 A
Evaporating temperature	-10.0 °C	Coefficient of performance (COP/EER)	2.41
<i>Evaporating pressure (abs.)</i>	<i>3.58 bar</i>	Condensing capacity	103.00 kW
Condensing temperature	45.0 °C	Mass flow	0.521 kg/s
<i>Condensing pressure (abs.)</i>	<i>18.75 bar</i>	Discharge end temperature	81.1 °C <sup>1)</sup>
Suction gas superheat	8 K		
Subcooling (outside cond.)	0 K		
Usable superheat	100%		

*Preliminary capacity data.*



- 
- 1) The stated value of the discharge end temperature is a mere calculated value. Additional cooling and heat dissipation are not considered. Deviations (particularly in deep freezing applications) from the real measured discharge temperature during operation are possible.

**Subject:**

---

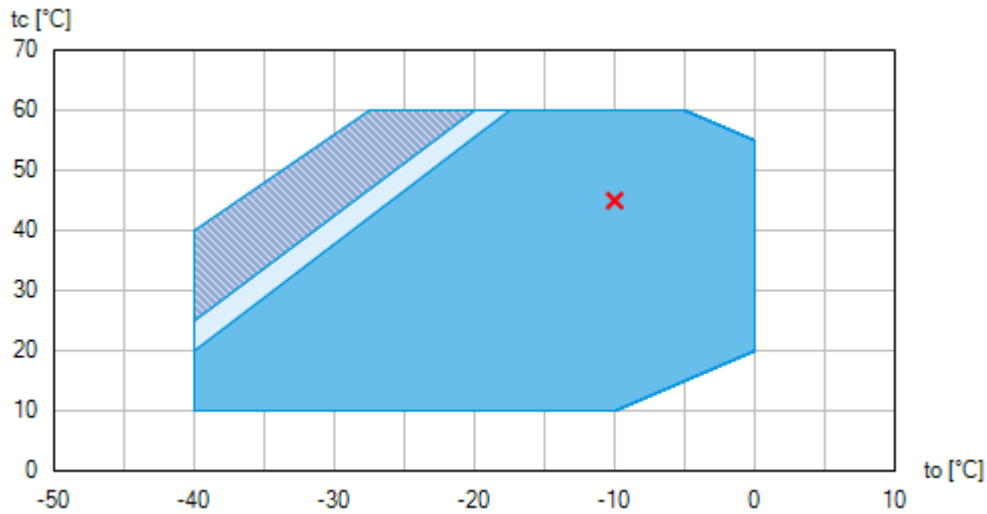
## Operating limits



-  Unlimited application range
-  Supplementary cooling or reduced suction gas temperature ( $\Delta t_{oh} < 20K$ )
-  Supplementary cooling and reduced suction gas temperature ( $\Delta t_{oh} < 20K$ )

Compressor operation is possible within the limits shown on the diagrams of application. Please note the coloured areas. Compressor application limits should not be chosen for design purposes or continuous operation. Axis values refer to dew point (saturated vapour line).

**Subject:**

**Technical data**

Number of cylinders / Bore / Stroke	6 / 80 mm / 58 mm
Displacement 50/60 Hz (1450/1740 <sup>1</sup> /min)	152,2 / 182,6 m <sup>3</sup> /h
Voltage <sup>1)</sup>	380-420V Y/YY -3- 50Hz PW
	440-480V Y/YY -3- 60Hz PW
Winding divided into	50% / 50%
Max. working current <sup>2)</sup>	71.9 A
Max. power consumption <sup>2)</sup>	42.4 kW
Starting current (rotor blocked) <sup>2)</sup>	196.0 / 335.0 A
Motor protection	INT69 G
Protection terminal box	IP 66
Weight	280 kg
Frequency range <sup>3)</sup>	25 - 60 Hz
Max. permissible overpressure (g) (LP/HP) <sup>4)</sup>	19 / 28 bar
Connection suction line SV	54 mm - 2 1/8 "
Connection discharge line DV	42 mm - 1 5/8 "
Lubrication	Oil pump
Oil type R134a, R404A, R407A/C/F, R448A, R449A, R450A, R513A	BOCKlub E55
Oil type R22	BOCKlub A46
Oil charge	4,4 Ltr.
Oil sump heater	230 V - 1 - 50/60 Hz, 160 W
Dimensions Length / Width / Height	810 / 557 / 467 mm
Sound power level L <sub>WA</sub> <sup>5)</sup>	88 dB(A) @ -35 °C / +40 °C
	83 dB(A) @ -10 °C / +45 °C
Sound pressure level L <sub>pA</sub> <sup>5)</sup>	75 dB(A) @ -35 °C / +40 °C
	70 dB(A) @ -10 °C / +45 °C

1) Tolerance (± 10%) relates to the mean value of the voltage range. Other voltages and current types on request

All data are based on voltage rms values

PW = part winding, motors for part winding starting  
 (no start unloaders required)  
 Designs for Y/D on request

Subject to change without notice



**Subject:**

---

- 2) - The stated value for the max. power consumption is valid for the adjusted power supply.
  - Starting current (rotor blocked):
    - Part winding (PW) motors: Winding 1 / Winding 1+2
    - Delta/Star ( $\Delta/Y$ ) motors:  $\Delta / Y$
  - Take account of the max. operating current / max. power consumption for designing motor contractors, feed lines, fuses and motor protection switches. Motor contractors: Consumption category AC3.
- 3) The maximum permissible working current of the compressor ( $I_{max}$ ) must not be exceeded. Take account of the guidelines for use of frequency inverter (see compressor assembly instruction or selection software).
- 4) LP = Low pressure  
HP = High pressure
- 5) Declared dual-number noise emission values are in accordance with ISO 4871. The corresponding uncertainty to the sound power level is  $K_{WA} = 2,5$  dB and to the sound pressure level is  $K_{pA} = 2,5$  dB. The values are valid for 50 Hz with the refrigerant R404A at the standard rating points according to EN 12900.
  - A-weighted sound power level  $L_{WA}$  (re 1 pW), in decibel. To determine the values, measurement methods of the ISO 3740 standard with accuracy class 2 or higher were used .
  - A-weighted sound pressure level  $L_{pA}$  (re 20  $\mu$ Pa), in decibel. The values are calculated from the sound power level in accordance with ISO 11203:  $L_{pA} = L_{WA} - Q_2$  at a distance of  $d = 1$  m to the reference box.

Subject to change without notice

---

To:

From:

14.03.2026  
Page 4 of 12



**Subject:**

**Performance data table**

Application: Refrigeration & AC  
 Reference temperature: Dew point  
 Supply frequency: 50 Hz  
 Voltage: 400 V  
 Suction gas superheat: 8 K  
 Subcooling (outside cond.): 0 K

tc [°C]		to [°C]									
		0.0	-5.0	-10.0	-15.0	-20.0	-25.0	-30.0	-35.0	-40.0	-45.0
10.0	Q [W]			119000	94800	74900	58400	44900	33900	25100	
	P [kW]			18.00	17.40	16.40	15.20	13.70	12.20	10.70	
	I [A]			39.90	39.20	38.30	37.20	36.00	34.80	33.70	
15.0	Q [W]		139000	113000	89700	70800	55100	42200	31600	23000	
	P [kW]		20.40	19.80	18.80	17.60	16.10	14.40	12.70	11.00	
	I [A]		42.40	41.70	40.70	39.50	38.10	36.60	35.20	33.90	
20.0	Q [W]	160000	131000	106000	84500	66600	51700	39300	29200	20800	
	P [kW]	23.20	22.60	21.70	20.30	18.80	17.00	15.10	13.10	11.20	
	I [A]	45.40	44.80	43.70	42.30	40.60	38.90	37.20	35.50	34.10	
25.0	Q [W]	151000	123000	99200	79200	62200	48100	36400	26700	18600	
	P [kW]	25.80	24.80	23.50	21.80	19.90	17.90	15.70	13.50	11.30	
	I [A]	48.50	47.30	45.70	43.90	41.80	39.70	37.70	35.80	34.20	
30.0	Q [W]	142000	115000	92700	73700	57800	44500	33400	24100	16200	
	P [kW]	28.40	27.00	25.30	23.30	21.00	18.60	16.20	13.70	11.30	
	I [A]	51.80	50.00	47.90	45.50	43.00	40.50	38.10	36.00	34.20	
35.0	Q [W]	132000	107000	86000	68200	53300	40800	30300	21400	13800	
	P [kW]	30.90	29.10	27.00	24.60	22.00	19.30	16.60	13.80	11.20	
	I [A]	55.10	52.70	50.00	47.00	44.10	41.20	38.50	36.10	34.10	
40.0	Q [W]	122000	98800	79200	62600	48700	37000	27100	18700	11400	
	P [kW]	33.40	31.10	28.60	25.80	22.90	19.80	16.80	13.80	10.90	
	I [A]	58.60	55.40	52.00	48.50	45.00	41.70	38.70	36.00	33.80	
45.0	Q [W]	113000	90600	72300	56900	44000	33100	23900	16000		
	P [kW]	35.70	33.00	30.10	26.90	23.60	20.20	16.80	13.50		
	I [A]	61.90	58.10	54.00	49.90	45.80	42.10	38.70	35.80		
50.0	Q [W]	103000	82400	65400	51200	39300	29200	20700			
	P [kW]	38.00	34.80	31.40	27.80	24.10	20.30	16.60			
	I [A]	65.20	60.60	55.80	51.00	46.40	42.20	38.50			
55.0	Q [W]	92700	74100	58500	45500	34500	25300	17400			
	P [kW]	40.00	36.40	32.50	28.40	24.30	20.20	16.10			
	I [A]	68.30	62.90	57.30	51.90	46.70	42.10	38.10			
60.0	Q [W]		65800	51500	39700	29800	21400				
	P [kW]		37.70	33.40	28.90	24.30	19.80				
	I [A]		64.90	58.50	52.40	46.80	41.70				

*Preliminary capacity data.*

-  Supplementary cooling or reduced suction gas temperature ( $\Delta t_{oh} < 20K$ )
-  Supplementary cooling and reduced suction gas temperature ( $\Delta t_{oh} < 20K$ )

Subject to change without notice

To:

From:

14.03.2026  
 Page 5 of 12

**BOCK® HGX66e/1750-4**  
Engine: 380-420V Y/YY -3- 50Hz PW  
Refrigerant: R449A



**Subject:**

---

*t<sub>o</sub>* Evaporating temperature  
*t<sub>c</sub>* Condensing temperature  
*Q* Compressor refrigeration capacity  
*P* Power consumption  
*I* Current draw

Subject to change without notice

---

To:

From:

14.03.2026  
Page 6 of 12

VAP 11.15.3 – [vap.danfoss.com](http://vap.danfoss.com)

**Subject:**

---

**Scope of supply**

Semi-hermetic six-cylinder reciprocating compressor with drive motor for part winding start  
Single-section compressor housing with hermetically integrated electric motor

Rear bearing flange prepared for oil differential pressure sensor DELTA-P II

Winding protection with PTC resistor sensors and electronic trigger unit INT69 G  
115-230 V AC, 50/60 Hz, IP00

Oil pump

Possibility of connection of oil level controllers ESK, AC+R or CARLY

Possibility of connection of oil level controllers Traxoil <sup>1)</sup>

Oil charge:  
HG: **BOCK**lub A46  
HGX: **BOCK**lub E55

Sight glass

Internal safety valve

Suction and discharge line valve

Inert gas charge

**Accessories**

Capacity regulator 110 V - 1 - 50/60 Hz, IP65  
1-2 capacity regulator = 66/33% residual capacity <sup>2)</sup>

Capacity regulator 230 V - 1 - 50/60 Hz, IP65  
1-2 capacity regulator = 66/33% residual capacity <sup>2)</sup>

Cylinder cover prepared for capacity regulator <sup>3)</sup>

Oil sump heater 230 V - 1 - 50/60 Hz, 160 W <sup>3)</sup>

USB converter for INT69 G Diagnose <sup>4)</sup>

Oil service valve

INT69 G Diagnose 115-230 V AC, 50/60 Hz, IP00 (INT69 G not applicable) <sup>3)</sup>

Oil pressure safety switch MP54 230 V - 1 - 50/60 Hz, IP20 <sup>4)</sup>

INT69 GTML Diagnose 115-230 V AC, 50/60 Hz, IP00, including oil differential pressure sensor INT250G,  
thermal protection thermostat per cylinder covers, (INT69 G not applicable) <sup>4)</sup>

Thermal protection thermostat per cylinder cover <sup>3)</sup>

Oil differential pressure sensor DELTA-P II 220-240 V - 1 - 50/60 Hz <sup>4)</sup>

Subject to change without notice



**Subject:**

---

Connection piece suction and discharge valve in welding design

Oil temperature sensor (Pt1000, for external evaluation) <sup>3)</sup>

Hot gas temperature sensor (Pt1000, for external evaluation) <sup>3)</sup>

Thermal protection thermostat per cylinder cover

Additional fan

230 V AC - 1 - 50 Hz, 97 W, IP44

230 V AC - 1 - 60 Hz, 128 W <sup>4)</sup>

Step protection <sup>4)</sup>

Injection nozzle for liquid injection <sup>4)</sup>

4 anti-vibration pads enclosed

Special voltage and/or frequency (on request)

- 
- 1) Only with additional adapter possible
  - 2) Capacity regulator premounted, control unit enclosed
  - 3) Mounted
  - 4) Enclosure

**BOCK® HGX66e/1750-4**  
Engine: 380-420V Y/YY -3- 50Hz PW  
Refrigerant: R449A



**Subject:**

---

## **Dimensions and connections**

Subject to change without notice

---

To:

From:

14.03.2026  
Page 9 of 12

VAP 11.15.3 – [vap.danfoss.com](http://vap.danfoss.com)



**Subject:**



**Maße Zubehör / Dimensions Accessories**

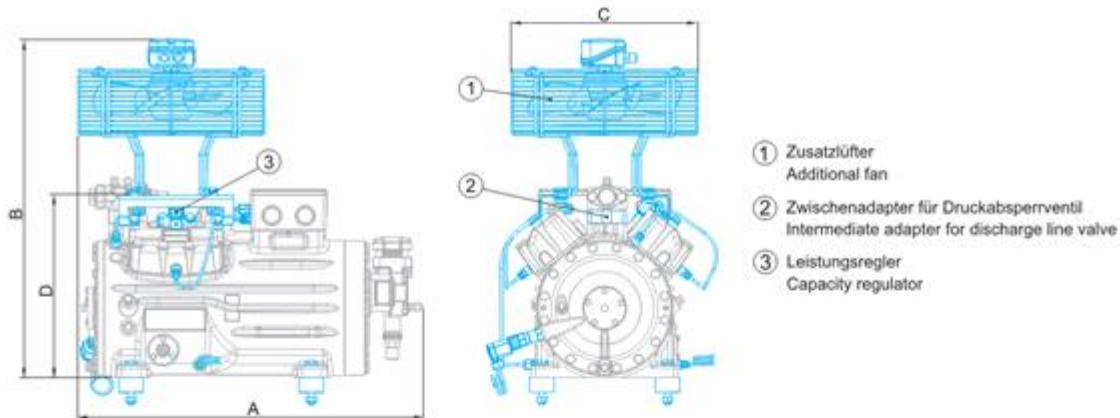

- ① Zusatzlüfter  
Additional fan
- ② Zwischenadapter für Druckabsperrentil  
Intermediate adapter for discharge line valve
- ③ Leistungsregler  
Capacity regulator

Typ / Type	A mm / inch	B mm / inch	C mm / inch	D mm / inch
HG12P	ca. 460 / 18	ca. 500 / 20	ca. 315 / 12	-
HG22e	ca. 525 / 21	ca. 610 / 24	ca. 380 / 15	-
HG34e	ca. 580 / 23	ca. 640 / 25	ca. 380 / 15	-
HG44e	ca. 710 / 28	ca. 685 / 27	ca. 380 / 15	ca. 368 / 14
HG56e	-	ca. 710 / 28	ca. 380 / 15	-
HG66e	ca. 820 / 32	ca. 800 / 31	ca. 380 / 15	-

Ansicht X: Anschlussmöglichkeit für Ölspiegelregulator  
 View X: Possibility of connection of oil level regulator

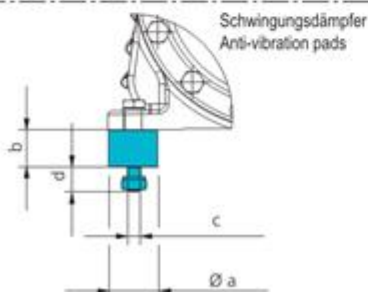
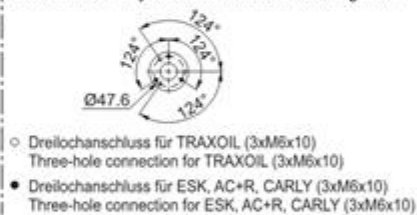

Typ / Type	Øa mm / inch	b mm / inch	c mm / inch	d mm / inch
HG12P	30 / 1.2	30 / 1.2	M8	20 / 0.8
HG22e	40 / 1.6	30 / 1.2	M10	20 / 0.8
HG34e	40 / 1.6	30 / 1.2	M10	20 / 0.8
HG44e	50 / 2.0	30 / 1.2	M12	25 / 1.0
HG56e	50 / 2.0	30 / 1.2	M12	25 / 1.0
HG66e	50 / 2.0	30 / 1.2	M12	25 / 1.0
HG88e	70 / 2.8	45 / 1.8	M12	37 / 1.5

ange without notice



**Subject:**

SV	Suction line valve, tube $\varnothing$ <sup>1)</sup>	54 mm - 2 1/8 "
DV	Discharge line valve, tube $\varnothing$ <sup>1)</sup>	42 mm - 1 5/8 "
A	Connection suction side, not lockable	1/8 " NPTF
A1	Connection suction side, lockable	7/16 " UNF
B	Connection discharge side, not lockable	1/8 " NPTF
B1	Connection discharge side, lockable	7/16 " UNF
C	Connection oil pressure safety switch OIL	1/8 " NPTF
D	Connection oil pressure safety switch LP	7/16 " UNF
D1	Connection oil return from oil separator	1/4 " NPTF
F	Oil drain	M 12 x 1.5
H	Oil charge plug	1/4 " NPTF
I	Connection hot gas temperature sensor	1/8 " NPTF
J	Connection oil sump heater	3/8 " NPTF
K	Sight glass	3 x M 6
L	Connection thermal protection thermostat	1/8 " NPTF
M	Oil strainer	M 12 x 1.5
O	Connection oil level regulator	3 x M 6
ÖV	Connection oil service valve	1/4 " NPTF
P	Connection oil differential pressure sensor	M 20 x 1.5
Q	Connection oil temperature sensor	1/8" NPTF
W	Connection for refrigerant injection	2 x 1/8" NPTF

1) Brazing connection

**BOCK® HGX66e/1750-4**  
Engine: 380-420V Y/YY -3- 50Hz PW  
Refrigerant: R449A



**Subject:**

---

**Product photo**



---

Subject to change without notice

To:

From:

14.03.2026  
Page 12 of 12

VAP 11.15.3 – [vap.danfoss.com](http://vap.danfoss.com)