



Subject:

Performance data

Application: Refrigeration & AC

Refrigerant	R449A	Compressor refrigeration capacity	101.00 kW
Reference temperature	Dew point	Evaporator refrigeration capacity	101.00 kW
Power supply	50 Hz, 400 V	Power consumption	42.30 kW
Supply frequency	50 Hz	Current draw (400 V)	75.80 A
Evaporating temperature	-10.0 °C	Coefficient of performance (COP/EER)	2.37
<i>Evaporating pressure (abs.)</i>	<i>3.58 bar</i>	Condensing capacity	143.00 kW
Condensing temperature	45.0 °C	Mass flow	0.723 kg/s
<i>Condensing pressure (abs.)</i>	<i>18.75 bar</i>	Discharge end temperature	81.8 °C ¹⁾
Suction gas superheat	8 K		
Subcooling (outside cond.)	0 K		
Usable superheat	100%		



Preliminary capacity data.

-
- 1) The stated value of the discharge end temperature is a mere calculated value. Additional cooling and heat dissipation are not considered. Deviations (particularly in deep freezing applications) from the real measured discharge temperature during operation are possible.

Subject:

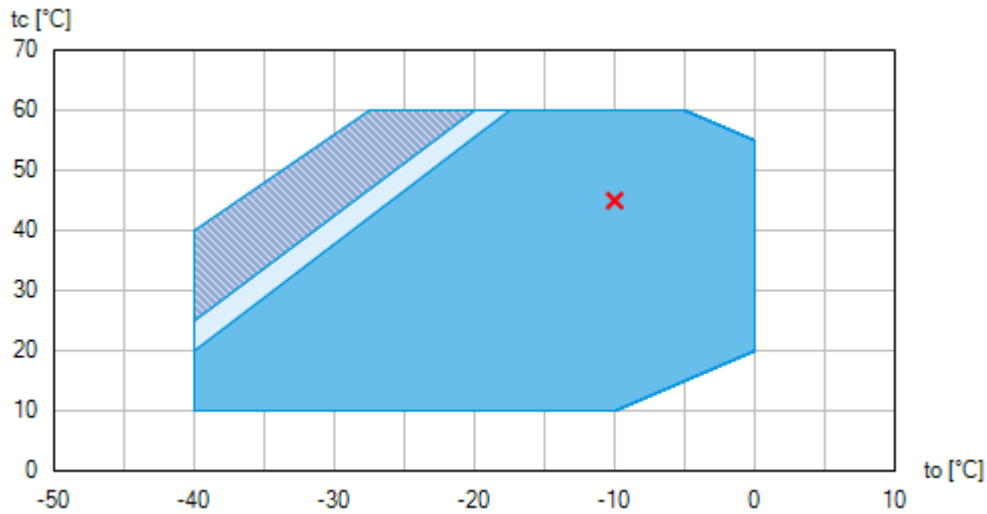
Operating limits



-  Unlimited application range
-  Supplementary cooling or reduced suction gas temperature ($\Delta t_{oh} < 20K$)
-  Supplementary cooling and reduced suction gas temperature ($\Delta t_{oh} < 20K$)

Compressor operation is possible within the limits shown on the diagrams of application. Please note the coloured areas. Compressor application limits should not be chosen for design purposes or continuous operation. Axis values refer to dew point (saturated vapour line).

Subject:

Technical data

Number of cylinders / Bore / Stroke	8 / 75 mm / 68 mm
Displacement 50/60 Hz (1450/1740 ¹ /min)	209,1 / 250,9 m ³ /h
Voltage ¹⁾	380-420V Y/YY -3- 50Hz PW
	440-480V Y/YY -3- 60Hz PW
Winding divided into	50% / 50%
Max. working current ²⁾	101.0 A
Max. power consumption ²⁾	59.5 kW
Starting current (rotor blocked) ²⁾	385.0 / 543.0 A
Motor protection	INT69 G
Protection terminal box	IP 65
Weight	452 kg
Frequency range ³⁾	25 - 60 Hz
Max. permissible overpressure (g) (LP/HP) ⁴⁾	19 / 28 bar
Connection suction line SV	76 mm - 3 1/8 "
Connection discharge line DV	54 mm - 2 1/8 "
Lubrication	Oil pump
Oil type R134a, R404A, R407A/C/F, R448A, R449A, R450A, R513A	BOCKlub E55
Oil type R22	BOCKlub A46
Oil charge	9,6 Ltr.
Oil sump heater	230 V - 1 - 50/60 Hz, 200 W
Dimensions Length / Width / Height	943 / 648 / 656 mm
Sound power level L _{WA} ⁵⁾	89 dB(A) @ -35 °C / +40 °C
	86 dB(A) @ -10 °C / +45 °C
Sound pressure level L _{pA} ⁵⁾	76 dB(A) @ -35 °C / +40 °C
	72 dB(A) @ -10 °C / +45 °C

1) Tolerance (± 10%) relates to the mean value of the voltage range. Other voltages and current types on request

All data are based on voltage rms values

PW = part winding, motors for part winding starting
 (no start unloaders required)
 Designs for Y/D on request

Subject to change without notice



Subject:

- 2) - The stated value for the max. power consumption is valid for the adjusted power supply.
 - Starting current (rotor blocked):
 - Part winding (PW) motors: Winding 1 / Winding 1+2
 - Delta/Star (Δ/Y) motors: Δ / Y
 - Take account of the max. operating current / max. power consumption for designing motor contractors, feed lines, fuses and motor protection switches. Motor contractors: Consumption category AC3.
- 3) The maximum permissible working current of the compressor (I_{max}) must not be exceeded. Take account of the guidelines for use of frequency inverter (see compressor assembly instruction or selection software).
- 4) LP = Low pressure
HP = High pressure
- 5) Declared dual-number noise emission values are in accordance with ISO 4871. The corresponding uncertainty to the sound power level is $K_{WA} = 2,5$ dB and to the sound pressure level is $K_{pA} = 2,5$ dB. The values are valid for 50 Hz with the refrigerant R404A at the standard rating points according to EN 12900.
 - A-weighted sound power level L_{WA} (re 1 pW), in decibel. To determine the values, measurement methods of the ISO 3740 standard with accuracy class 2 or higher were used .
 - A-weighted sound pressure level L_{pA} (re 20 μ Pa), in decibel. The values are calculated from the sound power level in accordance with ISO 11203: $L_{pA} = L_{WA} - Q_2$ at a distance of $d = 1$ m to the reference box.

Subject to change without notice

To:

From:

14.03.2026
Page 4 of 11





Subject:

Performance data table

Application: Refrigeration & AC
 Reference temperature: Dew point
 Supply frequency: 50 Hz
 Voltage: 400 V
 Suction gas superheat: 8 K
 Subcooling (outside cond.): 0 K

tc [°C]		to [°C]									
		0.0	-5.0	-10.0	-15.0	-20.0	-25.0	-30.0	-35.0	-40.0	-45.0
10.0	Q [W]			164000	131000	104000	80700	62000	46900	34700	
	P [kW]			25.50	24.70	23.40	21.70	19.70	17.60	15.40	
	I [A]			53.60	52.70	51.20	49.30	47.30	45.20	43.10	
15.0	Q [W]		191000	155000	124000	97800	76100	58300	43700	31800	
	P [kW]		28.70	28.00	26.70	25.00	22.90	20.70	18.20	15.80	
	I [A]		57.60	56.60	55.10	53.10	50.70	48.30	45.80	43.50	
20.0	Q [W]	221000	181000	146000	117000	92000	71400	54400	40400	28800	
	P [kW]	32.50	31.80	30.50	28.80	26.60	24.20	21.60	18.80	16.10	
	I [A]	62.30	61.40	59.80	57.60	55.00	52.10	49.20	46.40	43.80	
25.0	Q [W]	208000	170000	138000	110000	86000	66500	50300	36900	25700	
	P [kW]	36.10	34.80	33.00	30.80	28.20	25.40	22.40	19.40	16.40	
	I [A]	67.20	65.50	63.10	60.20	56.90	53.50	50.10	46.90	44.00	
30.0	Q [W]	195000	159000	129000	102000	79900	61500	46200	33400	22500	
	P [kW]	39.70	37.90	35.50	32.80	29.70	26.50	23.10	19.70	16.40	
	I [A]	72.20	69.60	66.40	62.70	58.80	54.80	50.90	47.30	44.10	
35.0	Q [W]	183000	148000	119000	94400	73700	56400	41900	29700	19300	
	P [kW]	43.30	40.90	37.90	34.60	31.10	27.40	23.60	19.90	16.30	
	I [A]	77.30	73.80	69.70	65.20	60.50	55.90	51.50	47.50	43.90	
40.0	Q [W]	169000	137000	110000	86700	67400	51200	37600	26000	15900	
	P [kW]	46.80	43.70	40.20	36.30	32.30	28.10	23.90	19.80	15.90	
	I [A]	82.40	77.90	72.80	67.50	62.10	56.80	51.90	47.40	43.60	
45.0	Q [W]	156000	126000	101000	78900	61000	45900	33200	22300		
	P [kW]	50.20	46.40	42.30	37.90	33.30	28.60	24.00	19.50		
	I [A]	87.30	81.80	75.80	69.60	63.40	57.40	51.90	47.10		
50.0	Q [W]	143000	115000	90800	71000	54500	40600	28800			
	P [kW]	53.30	48.90	44.10	39.10	34.00	28.80	23.80			
	I [A]	91.90	85.40	78.50	71.30	64.30	57.70	51.70			
55.0	Q [W]	129000	103000	81300	63100	48000	35200	24300			
	P [kW]	56.20	51.10	45.70	40.10	34.40	28.70	23.20			
	I [A]	96.20	88.70	80.70	72.70	64.90	57.60	51.00			
60.0	Q [W]		91500	71600	55100	41400	29900				
	P [kW]		53.10	47.00	40.70	34.50	28.20				
	I [A]		91.50	82.60	73.60	65.00	57.00				

Preliminary capacity data.

-  Supplementary cooling or reduced suction gas temperature ($\Delta t_{oh} < 20K$)
-  Supplementary cooling and reduced suction gas temperature ($\Delta t_{oh} < 20K$)

Subject to change without notice

BOCK® HGX88e/2400-4
Engine: 380-420V Y/YY -3- 50Hz PW
Refrigerant: R449A



Subject:

t_o Evaporating temperature
t_c Condensing temperature
Q Compressor refrigeration capacity
P Power consumption
I Current draw

Subject to change without notice

To:

From:

14.03.2026
Page 6 of 11

VAP 11.15.3 – vap.danfoss.com

Subject:

Scope of supply

Semi-hermetic eight-cylinder reciprocating compressor with drive motor
Single-section Compressor housing with hermetically integrated electric motor

Winding protection with PTC resistor sensors and electronic trigger unit INT69 G
115-230 V AC, 50/60 Hz, IP00

Oil pump

Possibility of connection of oil level controllers ESK, AC+R or CARLY

Oil pump cover with screw-in option for oil differential pressure sensor DELTA-P II

Possibility of connection of oil level controllers Traxoil ¹⁾

Oil charge:

HG: **BOCK**lub A46

HGX: **BOCK**lub E55

Three sight glasses

Pressure relief valve

Suction and discharge line valve

Inert gas charge

Accessories

Capacity regulator 110 V - 1 - 50/60 Hz, IP65
1-3 capacity regulator = 75/50/25% residual capacity ²⁾

Capacity regulator 230 V - 1 - 50/60 Hz, IP65
1-3 capacity regulator = 75/50/25% residual capacity ²⁾

Cylinder cover prepared for capacity regulator

Oil sump heater 230 V - 1 - 50/60 Hz, 200 W ³⁾

Oil service valve ³⁾

INT69 GTML Diagnose 115-230 V AC, 50/60 Hz, IP00, including oil differential pressure sensor INT250G,
thermal protection thermostat per cylinder covers, (INT69 G not applicable)

Oil pressure safety switch MP54 230 V - 1 - 50/60 Hz, IP20 ⁴⁾

Thermal protection thermostat per cylinder cover ³⁾

Connection piece suction and discharge valve in welding design

Oil differential pressure sensor DELTA-P II 220-240 V - 1 - 50/60 Hz ⁴⁾

Oil temperature sensor (Pt1000, for external evaluation) ³⁾

Subject to change without notice



Subject:

Hot gas temperature sensor (Pt1000, for external evaluation) ³⁾

Thermal protection thermostat per cylinder cover

USB converter for INT69 G Diagnose and INT69 GTML Diagnose ⁴⁾

Additional fan
230 V AC - 1 - 50 Hz, 97 W, IP44
230 V AC - 1 - 60 Hz, 128 W ⁴⁾

Intermediate adapter for discharge line valve ⁴⁾

Step protection

4 anti-vibration pads enclosed

Special voltage and/or frequency (on request)

-
- 1) Only with additional adapter possible
 - 2) Capacity regulator premounted, control unit enclosed
 - 3) Mounted
 - 4) Enclosure

Subject:

Dimensions and connections

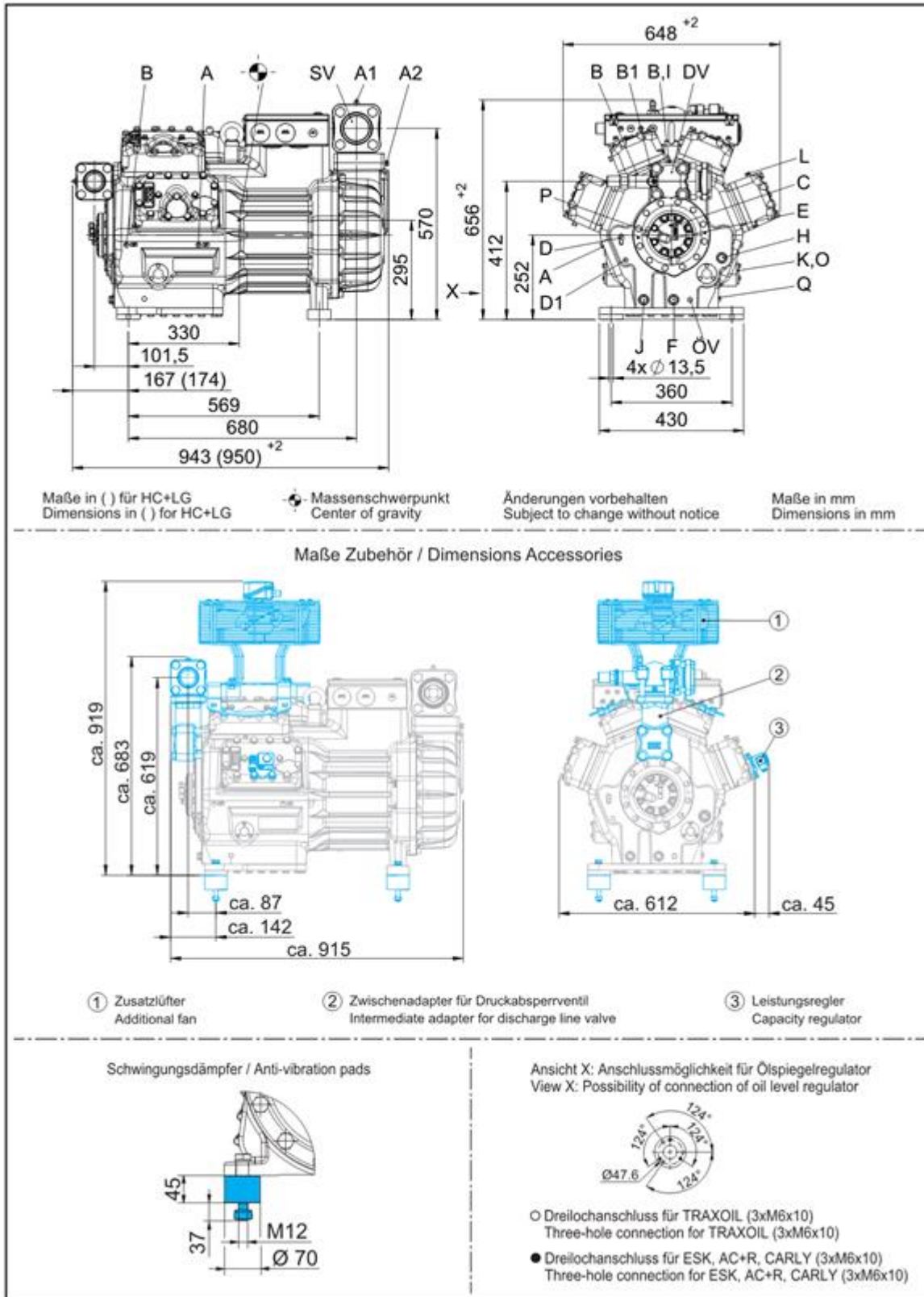

Subject to change without notice

To:

From:

14.03.2026
 Page 9 of 11



Subject:

SV	Suction line valve, tube \varnothing ¹⁾	76 mm - 3 1/8 "
DV	Discharge line valve, tube \varnothing ¹⁾	54 mm - 2 1/8 "
A	Connection suction side, not lockable	1/8 " NPTF
A1	Connection suction side, lockable	7/16 " UNF
A2	Connection suction side, not lockable	1/4 " NPTF
B	Connection discharge side, not lockable	1/8 " NPTF
B1	Connection discharge side, lockable	7/16 " UNF
C	Connection oil pressure safety switch OIL	7/16 " UNF
D	Connection oil pressure safety switch LP	7/16 " UNF
D1	Connection oil return from oil separator	1/4 " NPTF
E	Connection oil pressure gauge	7/16 " UNF
F	Oil drain	M 22 x 1.5
H	Oil charge plug	M 22 x 1.5
I	Connection hot gas temperature sensor	1/8 " NPTF
J	Connection oil sump heater	M 22 x 1.5
K	Sight glass	3 x M 6
L	Connection thermal protection thermostat	1/8 " NPTF
O	Connection oil level regulator	3 x M 6
ÖV	Connection oil service valve	1/4 " NPTF
P	Connection oil differential pressure sensor	M 20 x 1.5
Q	Connection oil temperature sensor	1/8 " NPTF

1) Brazing connection

BOCK® HGX88e/2400-4
Engine: 380-420V Y/YY -3- 50Hz PW
Refrigerant: R449A



Subject:

Product photo



Subject to change without notice

To:

From:

14.03.2026
Page 11 of 11

VAP 11.15.3 – vap.danfoss.com